

Super Hoop Multi-Mount Step Installation Instructions

Part No's: 121241 / 121242 / 121244



Quality and Style that Endures

Follow the diagram and the written directions carefully for a proper, safe installation.

Should you encounter an unusual, unforeseen problem, contact our Technical Help Line

7:00 AM – 3:00 PM Pacific

Time

(951) 719-1068

Visit our web-site at

www.CARR.com

Carr Pattern Co., Inc.

Vehicle Application:

JEEP

'07-'17 JK Wrangler

MATERIAL NEEDED:

Drill Motor, 5/16" drill bit, 1/8" drill bit, 2 - 1/2" wrench, 2 - 7/16" wrench, Phillips screw driver, pencil.

MATERIAL FURNISHED:

2 – Super Hoop step castings, 4 – Large mounting brackets, 4 – , 2 – Hardware packs, 1 – Instruction. **(Important! Not all of the parts in these hardware packs may be needed for proper installation).**

Diagram A
Front doors only

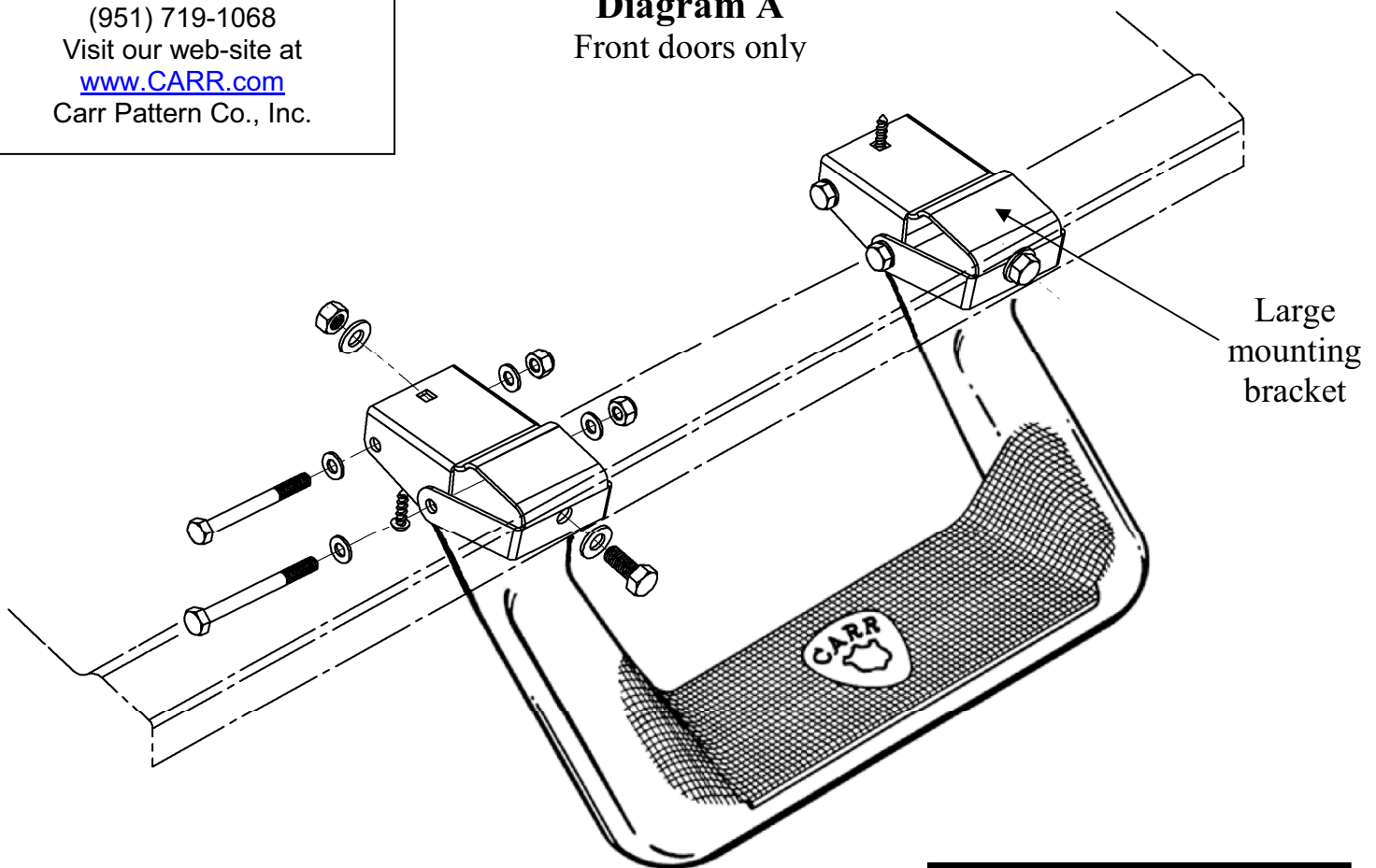

**WAX YOUR STEP ON A
REGULAR BASIS TO
MAINTAIN ITS LUSTER**



Super Hoop Multi-Mount Step Installation Instructions

Part No's: 121241 / 121242 / 121244



WARNINGS!

- ✓ Do not over tighten the nuts and bolts or damage to the castings and or stripping of the threads could result.
- ✓ FOR SAFE AND PROPER USAGE OF THIS PRODUCT, THE MOUNTING INSTRUCTIONS MUST BE FOLLOWED CAREFULLY AND COMPLETELY.
- ✓ The manufacturer and distributor of this product are in no way responsible for the consumer's failure to adhere to the warnings and directions of these instructions in the event of damage to the consumer's vehicle, other properties and or personal injury.

1. For the proper position of the step, the front edge of the seat while in normal driving position should be in line with the center of the step. For personal preference or to avoid any obstruction underneath body metal, step can be moved left or right.
2. Assemble the steel brackets to the step as shown in the Diagram A, and securely tighten.
3. When positioning the step against the body metal, be sure to avoid all bumps and screws to make sure that the step assembly is against a flat surface.
4. When the desired location is found, while holding the step in that position, take a short pencil and mark through the hole located in the front of each large mounting bracket onto the body metal.
5. Center punch the marked hole
6. Take a 1/8" drill bit and drill out the centered punched holes.
7. Replace the 1/8" drill bit and drill out the 1/8" hole for the marked 5/16" hole with a 5/16" drill bit.
8. After drilling, make sure that all the burrs are removed.
9. Place the step assembly back on the vehicle where the holes are drilled.
10. Take the 5/16" hardware that is provided and securely tighten the both large mounting brackets to the vehicle. See Diagram A.
11. Take a 1/8" drill bit and drill two more holes through the square holes that are located on each large mounting bracket.
12. Take the sheet metal screws provided and securely tighten.
13. Repeat all the above for the other side of your vehicle.
14. Make sure all hardware is securely tightened and that all the directions of this instruction have been followed carefully and completely, otherwise product failure could occur.

Carr Pattern Co., Inc.
Warranty Policy

Finishes: Limited Lifetime

Structural Warranty: Limited Lifetime

Warranty Conditions:

- a. All warranties start from consumer's date of purchase.
- b. A new product will be sent out immediately to replace a warranty claim.
- c. The above guidelines apply only to the Original Purchaser.
- d. Original proof of purchase must be submitted for all warranty and returns issues.

Warranty Limitations:

- a. Warranty coverage extends ONLY to repair or replacement of the CARR product. This warranty does not cover the cost of labor, transportation, installation or removal of the product.
- b. Warranty coverage does not extend to damage caused by: collision, fire, theft, freezing, vandalism, riot, explosion or object striking the product, or misuse of the product and/or the vehicle on which the product is being installed.
- c. Warranty coverage does not extend to damage caused by: airborne fallout (chemicals, tree sap, etc.), stones, hail, earthquake, water or flood, windstorm, lightning, the application of chemicals or sealants subsequent to manufacture.
- d. Warranty coverage does not extend to damages caused by: normal wear and tear, abuse, modification or improper installation of the product.
- e. Warranty coverage does not extend to any economic loss or extra expense including (without limitation), payment for the loss of time or pay, inconvenience, storage, loss of vehicle use, vehicle rental expense, equipment rental expense, lodging, meals, or other travel costs.

Other Terms:

This warranty gives you specific legal rights and you may also have other rights that vary from state to state. CARR does not authorize any person to create for it any other obligation or liability in connection with its products. ANY IMPLIED WARRANTY OF MERCHANTABILITY OR FITNESS FOR A PARTICULAR PURPOSE APPLICABLE TO THIS PRODUCT IS LIMITED IN DURATION TO THE DURATION OF THIS WRITTEN WARRANTY. PERFORMANCE OF REPAIRS AND NEEDED ADJUSTMENTS IS THE EXCLUSIVE REMEDY UNDER THIS WRITTEN WARRANTY OR ANY IMPLIED WARRANTY. CARR SHALL NOT BE LIABLE FOR INCIDENTAL OR CONSEQUENTIAL DAMAGES RESULTING FROM BREACH OF THIS WRITTEN WARRANTY.*

*Some states do not allow limitations on how long an implied warranty will last or the exclusion or limitation of incidental or consequential damages, so that above limitations or exclusions may not apply to you.

Guarantee: Every attempt has been made to manufacture and distribute the finest quality products available. Our manufactured products are guaranteed to be free of defects due to workmanship or materials. Distributed products are subject to manufacturer's warranty only.